

Venetian Marble, Inc.

SPECIFICATION DRAWING

Shower Pan **42-CORNER**

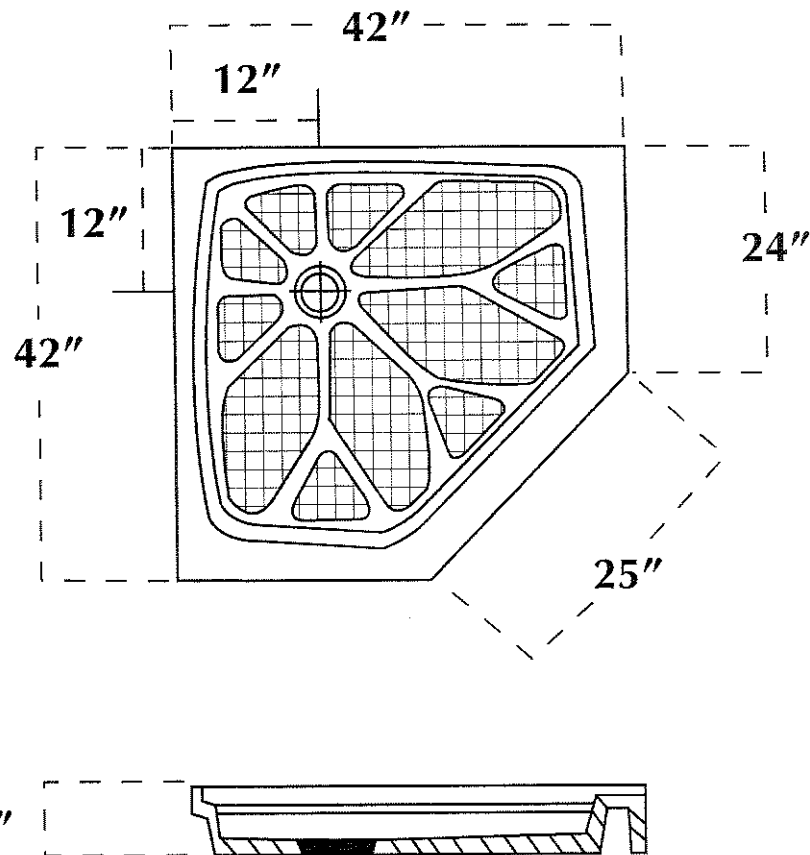

42-CORNER PAN

2150 Carter Gallier Blvd, Suite A, Powhatan, VA 23139
804.378.1190 / 804.378.1193 fax