

Venetian Marble, Inc.

SPECIFICATION DRAWING

Shower Pan **1051-05**

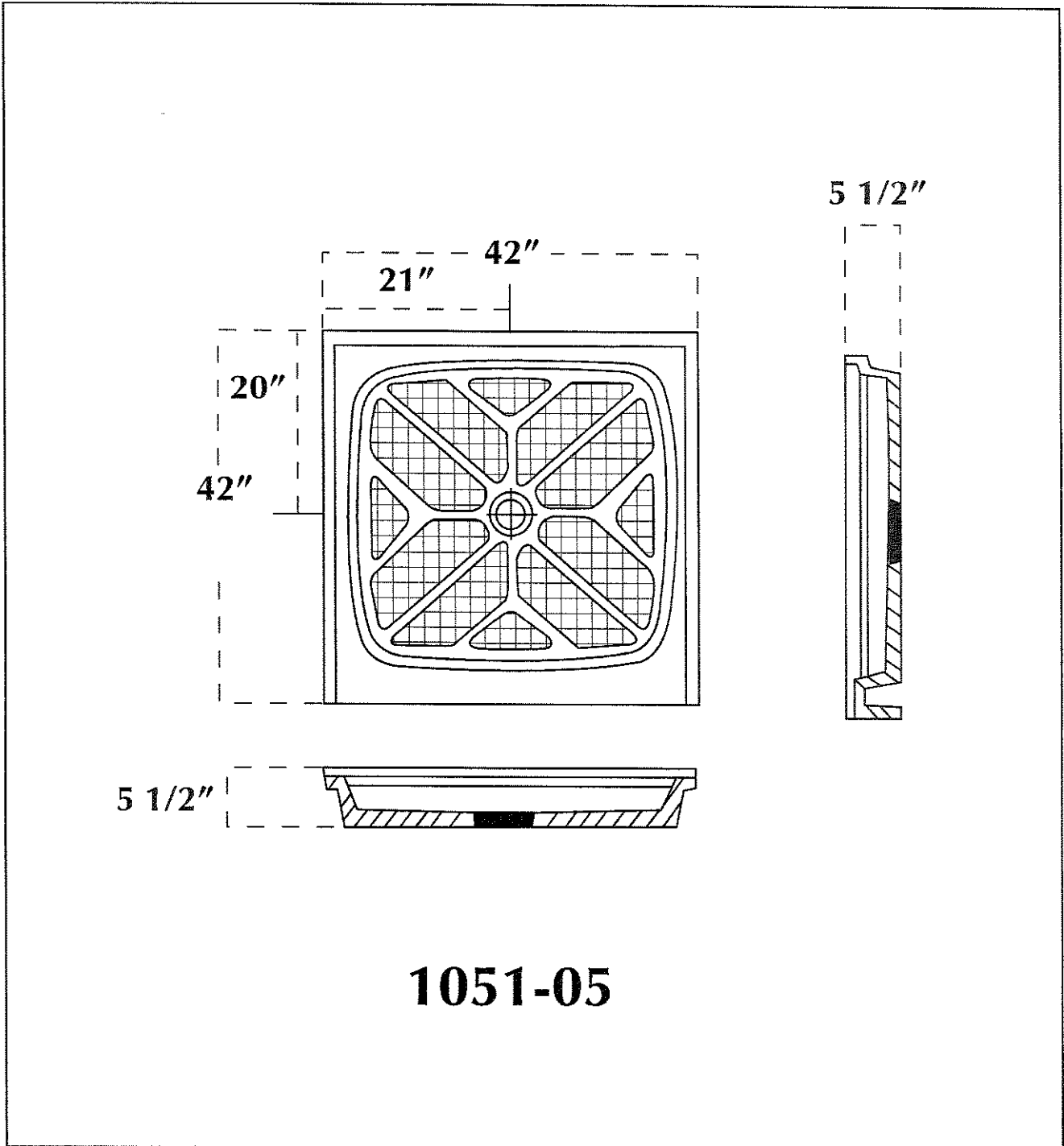

2150 Carter Gallier Blvd, Suite A, Powhatan, VA 23139
804.378.1190 / 804.378.1193 fax